

Air Uno

Salieri Evo Ceiling Hood

Version

1200mm – Stainless Steel – AMR10 Motor

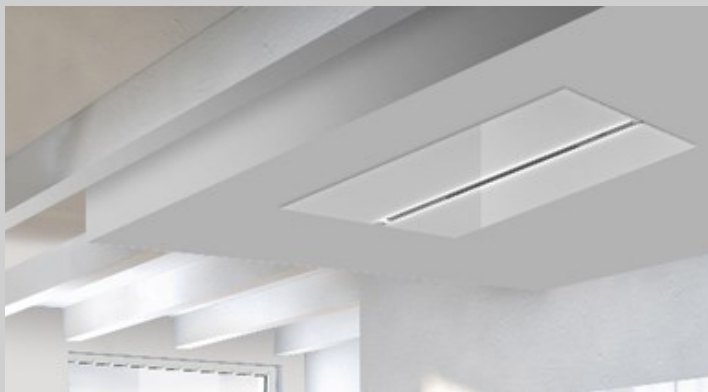

This photo is purely for information, it may not correspond to the selected version

FEATURES

Stainless Steel
Remote Control

TECHNICAL FEATURES

Installation Type

Ceiling

Dimensions

1200mm

Finish

Stainless Steel

Motor

AMR10 – 835m³/h

Type of Control

Remote Control

Speed Settings

4

Lighting

LED strip – 17W – 3000K

Filter

Metallic filter – 9x150x398mm

PACKAGING

Net Weight

21kg

Volume

0.31m³

Packaging Size

Length - 1300mm

Height - 345mm

Depth - 695mm

CONSUMPTION AND CONNECTION FEATURES

Maximum Consumption

362W

Current

3A Max

Voltage

220-240V

Motor Technical Data

Motor	AMR10 Motor
Airflow m ³ /h	835
Pressure Pa	580
Noise dB	40-73
Power W	345
Outlet Width mm	220x90
Energy Class	B

Cut-Out Dimensions:

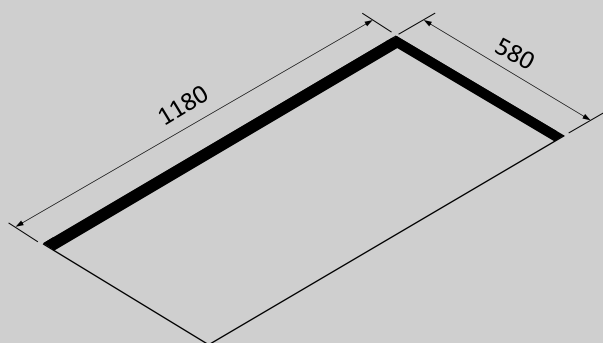

With Remote Motor

