



Mozart Downdraft Extractor



Installation & User Instructions

Please read these instructions carefully before installing and operating this appliance

Contents

1. Introduction	3
2. Health and Safety	3-4
3. Installation	4-8
3.1 Assembly Instructions	4-6
3.2 Motor Options	6
3.3 Re-Circulating Options	6-7
3.3.1 Plinth Charcoal Filter Kit	7
3.4 Electrical Wiring	7-9
3.4.1 Electrical Wiring Diagram	8
3.4.2 Controls	9
4. Use & Maintenance	9
4.1 Cleaning the Metal Filters	9
4.2 Carbon Filters	9-10
4.2.1 Polyester Carbon Filters	9
4.2.2 Long Life Carbon Filters	9-10
4.2 Cleaning the Hood	10
5. Technical Data	10
6. Dimensions	11-12
6.1 Mozart with AME, AMF or AMR Motor	11
6.2 Mozart with H850 Motor	12

1. Introduction

Dear Customer,



We wish to thank you for choosing this Air Uno cooker hood. In order to get the best performance from your appliance we recommend that you read this booklet carefully before operating the appliance for the first time.

Revisions to the publication

In order to improve the product, to keep this publication up to date the manufacturer reserves the right to make modification without any advance notice. Any reproduction, even in part, of this manual without the consent of the manufacturer is prohibited.

Care of the manual and how to consult it

- Take good care of this manual and keep it in a place which can be easily and quickly reached.
- If this manual should be lost or destroyed, or if it is in poor condition, ask for a copy from your retailer, providing product identification data.
- Information which is essential or that requires special attention is shown in bold text.

	ATTENTION This warning sign indicates that the message to which it refers should be carefully read and understood, because failure to comply with what these notices say can cause serious damage to the extractor and put the user's safety at risk.
	INFORMATION This symbol is used to highlight information which is important for proper extractor operation. Failure to comply with these provisions will compromise use of the boiler and its operation will not be satisfactory.
	MANUAL Indicates that you should carefully read this manual or the related instructions.

2. Health and Safety



- **Installation of the cooker hood, making electrical connections, checking its operation and maintenance are all tasks which should be carried out by qualified and authorised personnel.**

- **Install the cooker hood in accordance with the regulations in force in your local area, region and country.**
- For the correct use of the appliance and to prevent accidents, the instructions given in this booklet must always be followed.
- Before beginning any operation, the user, or whoever is preparing to operate on the appliance, must have read and understood the entire contents of this instruction booklet.
- All responsibility for improper use is taken entirely by the user and as such relieves Air Uno of any civil or criminal responsibility.
- In view of the fact that it is an electrical appliance, not touch the appliance with wet hands.
- Before carrying out any cleaning or maintenance operation, make sure in advance that the appliance is isolated from the mains electricity supply.
- Incorrect installation or faulty maintenance (not conforming to the requirements set out in this booklet) can cause harm to people, animals or property. In such cases Air Uno is absolved from any civil or criminal responsibility.

This product complies with EU Directive EU2002/96/EC.

The crossed bin symbol on the appliance indicates that the product, at the end of its life, must be disposed of separately from domestic waste, either by taking it to a separate waste disposal site for electric and electronic appliances or by returning it to your dealer when you buy another similar appliance. The user is responsible for taking the appliance to a special waste disposal site at the end of its life. If the disused appliance is collected correctly as separate waste, it can be recycled, treated and disposed of ecologically.

WARNINGS:

- **When the downdraft is closed, do not put pots or other containers on it.**
- This appliance can be used by children aged from 8 years and above and persons with reduced physical, sensory or mental capabilities, or lack of experience and knowledge if they have been given supervision or instruction concerning use of the appliance in a safe way and understand the hazards involved.
- Children shall not play with the appliance. Cleaning and user maintenance shall not be made by children without supervision.
- The downdraft is equipped with a security system of micro-switches, this blocks the

movement of the downdraft if the cover is dislodged. When closing the downdraft, if an object becomes trapped between the cover and the worktop the dislodging of the cover will immediately stop the downdraft. In order to reactivate the downdraft the cover will need to be replaced.

- Before cleaning or performing any periodic or urgent maintenance to the hood, isolate the mains supply and turn the main switch off.
- Do not connect the hood to any piping used for combustion appliances, such as burners, boilers or fire places.
- Check that the main power supply corresponds to the voltage required by the hood, which is given on the silver label stuck inside the hood. Ensure that the electric system is correctly earthed and that the earth discharge works correctly.
- When cooking do not use any materials that could form high or unusual flames. Oil that has been used twice and fats are very dangerous and could easily catch fire. Do not prepare flambé dishes under the hood.
- Once the specialised technician has completed the installation of the hood equipped with a remote motor, all the leads, connectors, ground connections and the remote motor must not be accessible to the user. Only the installer is granted access by removing screwed on panel.
- Respect local legislation and regulations issued by the relative authorities regarding the exhaust air when the suction is operating. Failure to respect and perform all maintenance and cleaning operations described in this handbook could cause a fire hazard.



ATTENTION: Accessible parts may become hot when the hood is used with cooking appliance.

3. Installation

The hood can be used for both filtering and suction. When the filtering function is operating, i.e. with air recycle, carbon filters must be used (refer to the paragraph on Carbon filters page 11).

When the suction function is operating i.e. exhausting the filtered air on the outside, a suitable compensation system must be used according to current standards in force. The diameter of the fume exhaust pipe must be the same or greater than the diameter of the hood pipe union.

There must be sufficient ventilation in the room where the hood is installed, to allow simultaneous use of other appliances that use gas or other fuels.



Ø150mm round or 220x90mm rectangular ducting must be used. Ducting with a smaller diameter could cause airflow issues.

3.1 Assembly Instructions

Attention: Before proceeding with the installation, make sure that the screws and the anchors already supplied, are suitable for the type of wall the hood must be fixed to.

To assemble the hood use the accessories that are supplied and follow the instructions given in the enclosed hand book.

How the Mozart should be laid out next to the hob

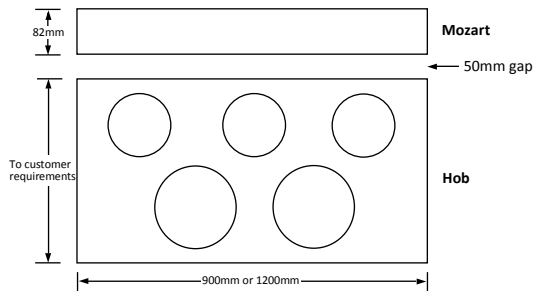

Fig 1

Mozart cut-out dimensions on top of worktop

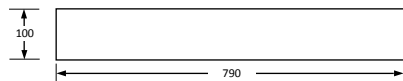

Fig 2

The hood is supplied with a side hinged cover support. The cover is available in steel, in glass, or in the same material used for the kitchen tops (not supplied).

1. Cut-out the hole in the work top and place the Mozart into the cupboard (**Fig 3**).

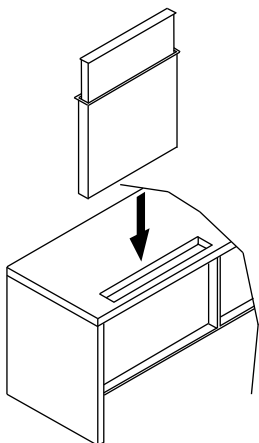

Fig 3

2. Fix the Mozart to the cupboard using the bracket provided (Fig 4).

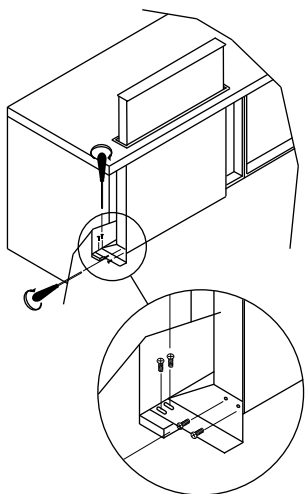

Fig 4

3. Depending on the thickness of the worktop and the cover, it is possible to achieve an adjustment of 20mm (Fig 5). This adjustment is possible by tightening or un-tightening the two screws that secure the central pivot of the actuator (Fig 6).

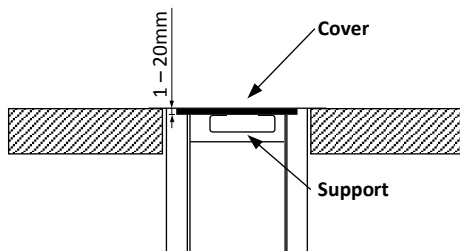

Fig 5

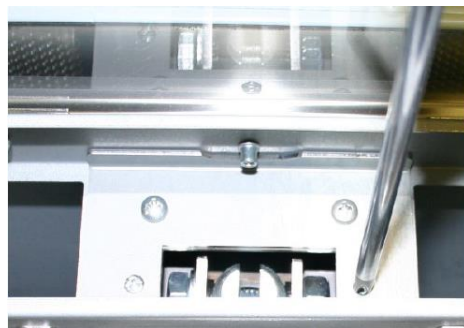

Fig 6

4. The gluing of the cover of the Mozart, must be performed after the installation of the Mozart into the worktop. The space between the lid and hole on the top should be about 1.5mm along the whole perimeter.

Caution: When the unit is positioned in the housing always leave an access panel. This will be needed should any technical assistance be required. An authorised service engineer must carry this out. Failure to comply with this condition will significantly increase the costs that could be charged in the case of any call outs.

1. Ducting will ideally be connected to the front or back of the Mozart. Remove the knock out panel with a hammer and fix the 150mm diameter plastic flange with the 4 screws included. Then connect the ducting. (Fig 7 & 8).

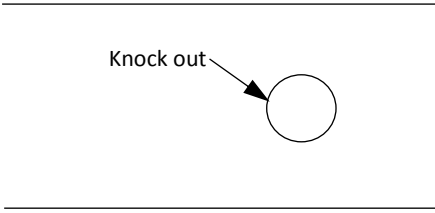

Fig 7

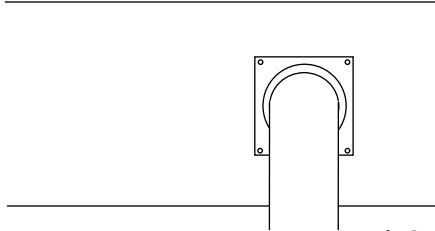

Fig 8

It is also possible to connect ducting to the side and bottom of the Mozart. Remove the knock out panel and fit the metal tray and 220x90 or 230x80 diameter plastic flange (Fig 9).

Extraction at the sides is difficult and only recommended when the other outlets cannot be used.

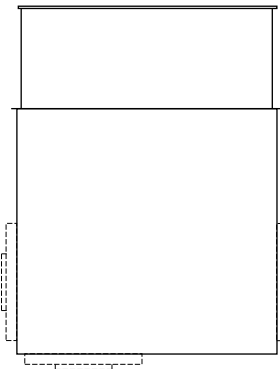

Fig 9

If you are using the AMD09 motor then this must be attached directly to either side of the Mozart (Fig 10).

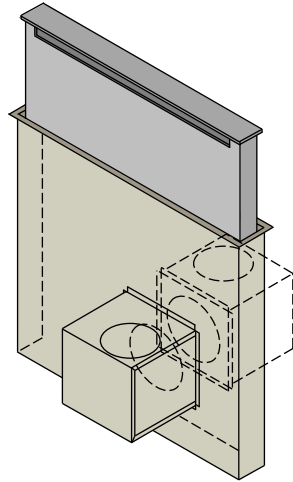

Fig 10

For the AMR09, AMR10, AMR20, AME12, AMF10 or AMF13 motors you can duct from any of the 3 points shown below (Fig 11).

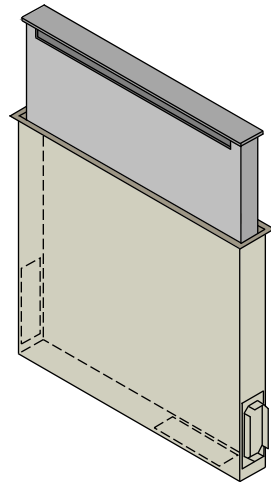

Fig 11

3.2 Motor Options

The Mozart can be used with any of the H850, AMR09, AMR10, AMR20, AME12, AMF10, AMF13 or AMD09 motors.

3.3 Re-circulating Options

The Mozart can be made re-circulating by using the Plinth charcoal filter kit.

3.3.1 Plinth Charcoal Filter Kit

This option can only be used with the AMF10 or AMF13 motor. It is installed into the plinth attached to the motor (Fig 12)

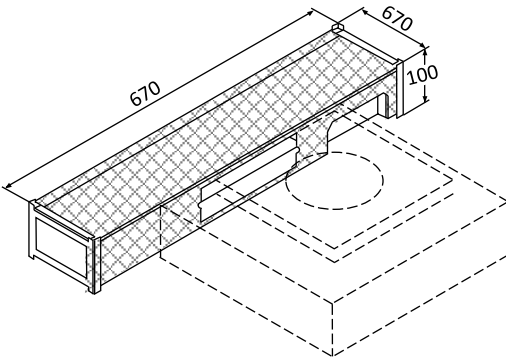

Fig 12

3.4 Electrical Wiring

The electrical wiring must be performed by a specialised electrician fully respecting current standards and legislation in force. **Check that the power supply corresponds to the voltage requested by the hood, which is given on the silver label stuck inside the hood.** Ensure that the wiring system conforms to current standards and the earth discharge works efficiently. Pay special attention to the hood power cable, ensure that it does not pass through any holes without a cable clamp. For direct connection to the electrical mains it is necessary to provide a device that ensures disconnection from the electrical mains, with an opening distance of the contacts allows the complete disconnection under the conditions of overvoltage category III, in accordance with the rules of installation. The plug or Omni polar switch must be accessible when the unit is installed. If the power cord is damaged, it must be replaced by a special cord or assembly available from the manufacturer or its service agent. The cable must be of type H05VV-F 3 x 0.75mm² minimum cross-section.

The manufacturer declines all responsibility if the current accident prevention standards in force are not respected, which are needed for the wiring system to operate correctly.

The label with the technical information is placed on the lid of the control box.

3.4.1 Electrical Wiring Diagram

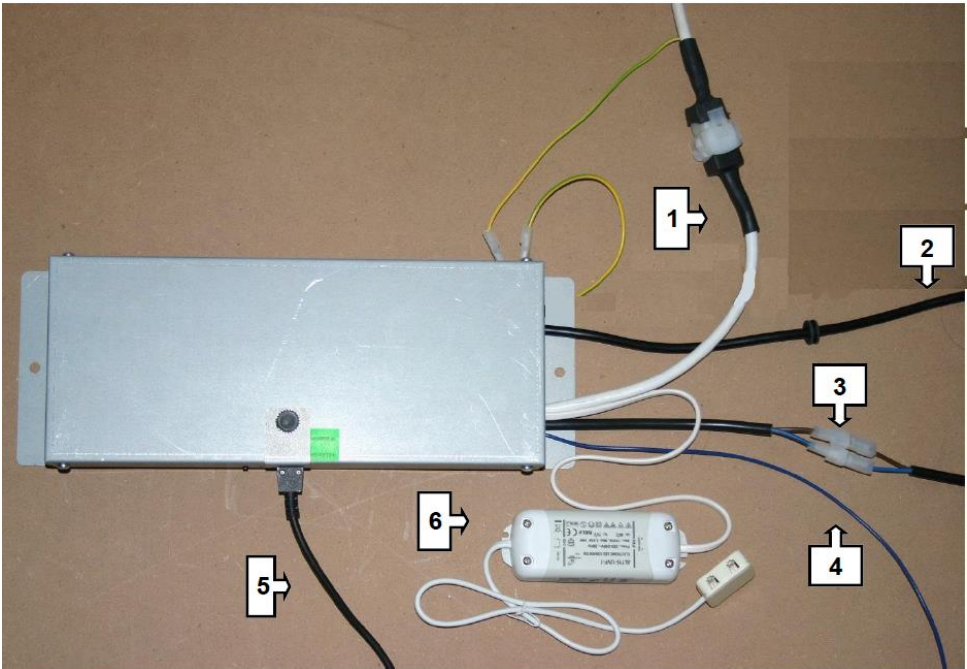

- 1) Motor Connector
- 2) Power supply 230V
- 3) Cable with faston for microswitch
- 4) Remote control antenna cable (must remain away from metal parts and/or electrical parts)
- 5) Control cable
- 6) Not applicable

3.4.2 Controls

The Mozart is controlled by remote control. This allows the user to control the hoods on/off functions and motor speeds.

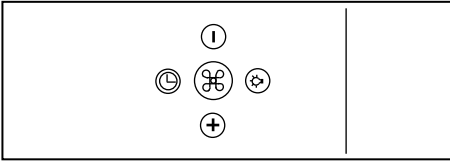

Fig 13

- ⊞ Turns motor on at speed 2 and for turning the motor off.
- ⊕ Increases motor speed.
- ⊖ Decreases motor speed.
- 💡 Turns lights on
- 🕒 Timer button for turning the motor off after 10 minutes.

On first use the user will need to pair the remote control with the Mozart. With the hood turned off, press and hold the black button on the control box until the LED flashes. Once this has happened press any button on the remote control to check all functions are working correctly.

4. Use & Maintenance

Before beginning any sort of cleaning or maintenance work, turn the power off to the hood by turning the main switch to 0 (OFF).

4.1 Cleaning the Metal Filters

The metal filters fitted in the hood should be washed every 2-3 months, depending on how much the hood is used, using hot water and a liquid detergent that is not too aggressive.

To access the metal filters, you must remove the cover by lifting it off the two securing magnets. The metal filters can be removed by using the special handle. Unhook the handle then pull upwards (Fig 14).

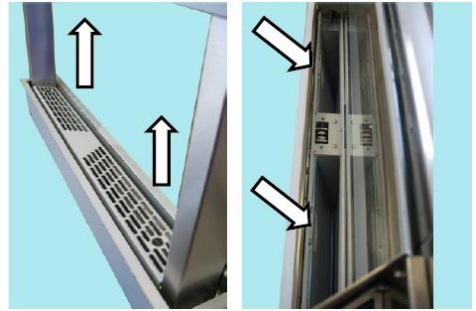

Fig 14

4.2 Carbon Filters

The hood can be used with active carbon filters which traps the cooking smells. There are either polyester or long life carbon filters and these are situated behind the grease filters.

4.2.1 Polyester Carbon Filters

These cannot be reused or washed and must be periodically changed (every 4 months if the hood is used for 2 hours every day). Saturated filters could be a fire hazard. The filters in the Mozart are rectangular.

4.2.2 Long Life Carbon Filters

These can be cleaned and reactivated. The filter should be cleaned every other month if used normally. The filter is best cleaned in a dishwasher at the highest temperature using normal washing detergent. The filter should be washed on its own to prevent particles of food from fastening in it and then causing an unpleasant smell later on (Fig 16). To reactivate, the carbon filter should be dried in the oven. Choose upper/lower heat and maximum 100°C and dry the filter for 10 minutes (Fig 17). The filter must be changed when it no longer absorbs the cooking smells sufficiently.

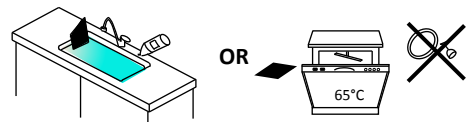

Fig 16

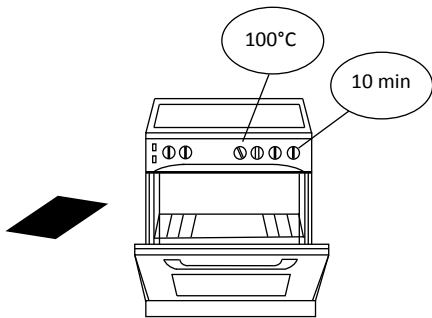

Fig 17

4.3 Cleaning the Hood

The surfaces of the hood should be cleaned frequently, to avoid the risk of having to remove built up and encrusted deposits and stains.

For the painted or copper plated hoods just a soft cloth with warm water and a neutral detergent. Do not pour the detergent directly onto the hood or use powdery or abrasive products. For the stainless steel hood, use special products and cloths for satin finish stainless steel (not abrasive, corrosive detergents or detergents containing chloride), ensuring to clean in the same direction as the satin finish.

Do not use aggressive products, chemical solvents or derivatives of oil distillates that could leave oily traces which could cause oxidation and polymerisation.

The manufacturer accepts no responsibility for damage to the surface of the hood due to failure to respect these instructions.

5. Technical Data

Mozart with H850 Motor	
Control	Remote control
Colour/finish	Stainless Steel
Airflow (m ³ /h)	330/750
Pressure (Pa)	564
Noise (db)	45-61
Power (W)	280
Voltage (V)	220-240
Outlet Width (mm)	150
Energy Class	B

6. Dimensions

6.1 Mozart with AME, AMF or AMR Motor

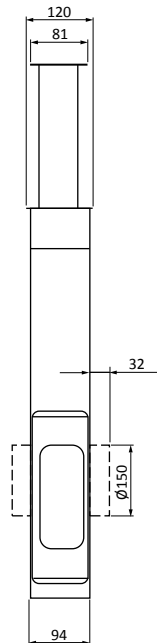
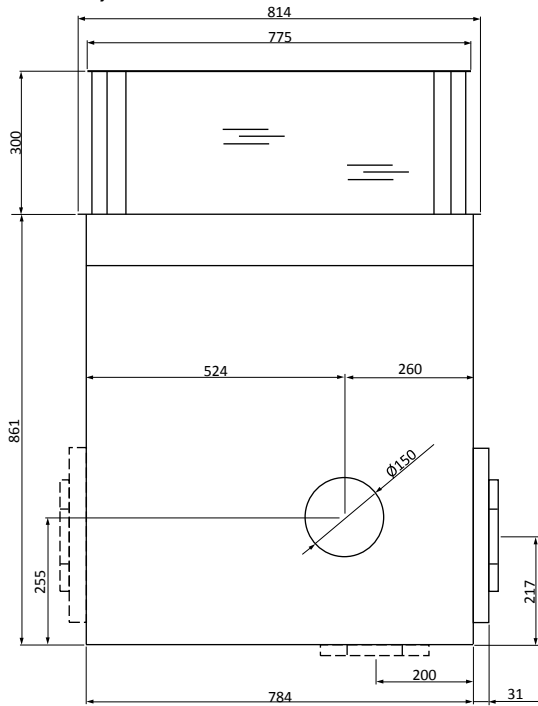

6.2 Mozart with H850 Motor

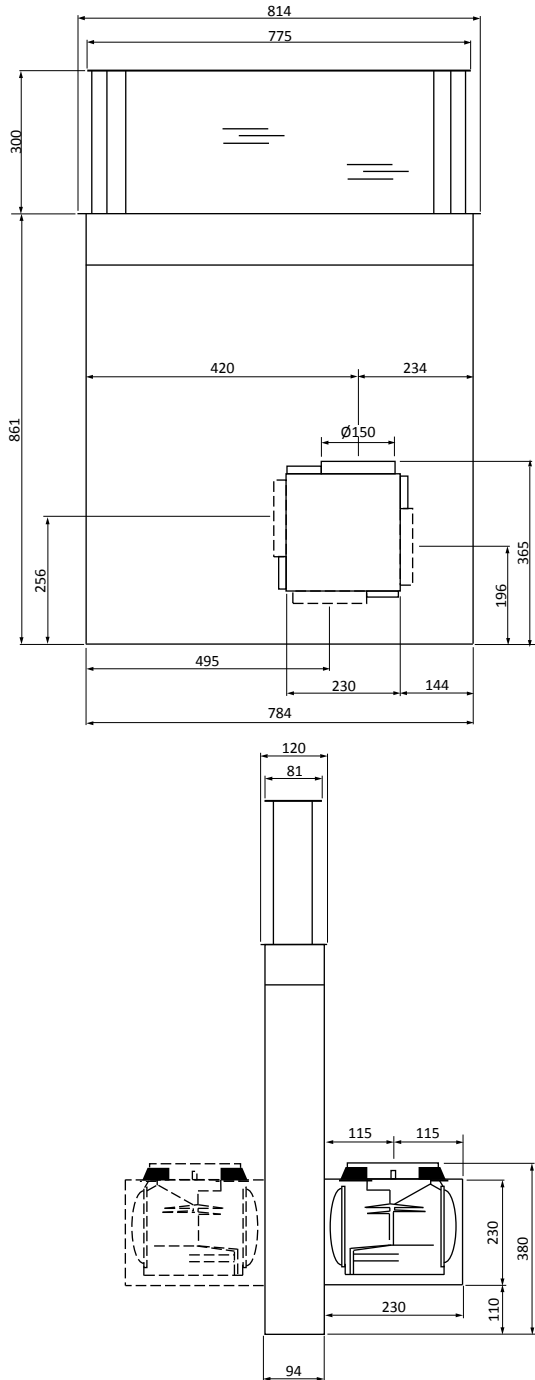



CD (UK) Ltd T/A Air Uno
Unit L, Wakefield House
Thistle Way
Gildersome Spur
Morley
West Yorkshire
LS27 7JZ

CD (UK) Ltd T/A Air Uno is a company registered in England and Wales Registration No. 2905619



Copyright of all contents of this leaflet is vested in CD (UK) Ltd t/a Air Uno. Any part may not be reproduced without permission. The contents of this leaflet are accurate at the date of printing but, because CD (UK) Ltd t/a Air Uno has a policy of continual development, it may be superseded and should be disregarded if specifications or appearances are changed. The statutory rights of the customer are not affected. E&OE's.