



## Raffaello Ceiling Hood

Version  
1200mm—White Panel & Stainless Steel Frame—  
AMF13 Motor



This photo is purely for information, it may not correspond to the selected version

### FEATURES

White Panel  
Stainless Steel Frame  
Remote Control

### TECHNICAL FEATURES

**Installation Type**  
Ceiling

**Dimensions**  
1200mm

**Finish**  
White Panel & Stainless Steel Frame

**Motor**  
AMF13— 418-705 (826)m<sup>3</sup>/h

**Type of Control**  
Remote Control

**Speed Settings**  
4

**Lighting**  
Dimmable LED panel—36W—  
3000K

**Filter**  
Metallic filter—9x220x290mm

### PACKAGING

**Net Weight**  
22kg

**Volume**  
0.3m<sup>3</sup>

**Packaging Size**  
Length - 1290mm  
Height - 330mm  
Depth - 710mm

### CONSUMPTION AND CONNECTION FEATURES

**Maximum Consumption**  
226W

**Current**  
3A Max

**Voltage**  
220-240V

### Motor Technical Data

Motor	AMF13 Motor
Airflow m <sup>3</sup> /h	418-705 (826)
Pressure Pa	772
Noise dB	64-80
Power W	190
Outlet Width mm	220x90
Energy Class	B

### Cut-Out Dimensions:

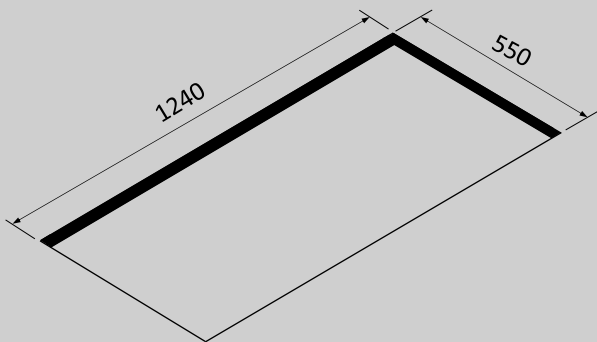

### Without Motor

